



























LEGEND

	4-year warranty		Non-Anodized
	Restriction of Hazardous Substance		Silver Anodized
	Recessed		Black Anodized
	Bendable		White
	Closet-Rated		Focusing Lens with 100% light transmission
	IP22		Universal Clear Pro with 91% light transmission
	Static White		Universal Frosted Pro with 80% light transmission
	High Density		Universal Clear with 85% light transmission
	Full Spectrum		Universal Frosted with 70% light transmission
	Side Emitting		Extreme Clear with 89% light transmission
	Ultra Slim		Extreme Frosted with 70% light transmission
	Dim to Warm		In-Ground Frosted with 58% light transmission
	Tunable White		Ultra Slim Frosted with 70% light transmission

*Most Xicato Channels are IP65 ready with proper sealant applied around the end caps to completely seal the XFL inside the channel.

Xicato designs and delivers one of the broadest portfolio spot and linear light sources and electronics that enable architects, designers and building managers to create beautiful, smart spaces in which people love to live and work. With thousands of installations around the globe, Xicato continues to be a leading supplier of high quality lighting solutions. Xicato is defining the future of intelligent light sources by integrating electronics, software and connectivity. Founded in 2007, Xicato has offices in China, Europe and the U.S., with it's headquarters based in Silicon Valley.

Project: _____
 Designer: _____
 Fixture: _____



See legend at beginning of document

Ultra Slim Channels

XCC-C-USS

Ultra Slim Square

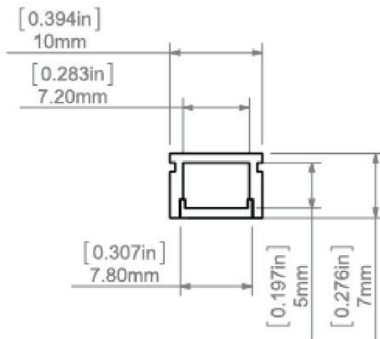
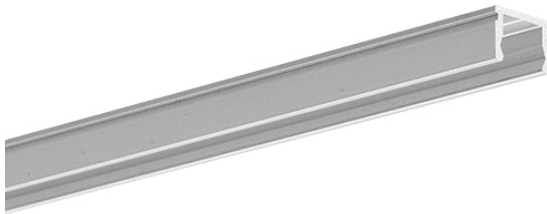

SKU				
Product	Collection	Name Code	Surface Code	Length
XCC	C	USS	SA	1
				2

Compatible XFL

22 - US

Description

Small and square profile of 7mm for those hard to light applications. Bendable into gentle curves at the plane adjacent to the LED strip with 150mm bending radius.

Material	XCC-E End Caps
SA	XCC-E-SLM-NA-NC-STD

XCC-L Lenses	Internal Channel Dimensions
US FR	Height: 5mm Width for LED: 7.2mm

70%
XCC-L-US-FR

XCC-C-USR

Ultra Slim Rectangle

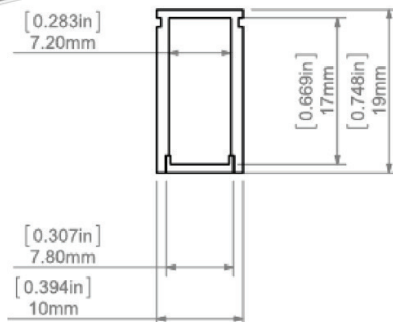
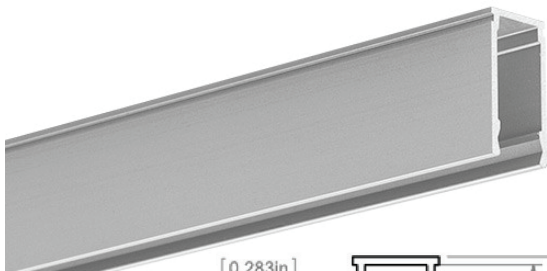

SKU				
Product	Collection	Name Code	Surface Code	Length
XCC	C	USR	SA	1
				2

Compatible XFL

22 - US

Description

Smallest extrusion for a single narrow line of light for interior design, furniture and exhibitions. Mounted with two-sided adhesive.

Material	XCC-E End Caps
SA	XCC-E-SLM-NA-NC-STD

XCC-L Lenses	Internal Channel Dimensions
US FR	Height: 17mm Width for LED: 7.2mm

70%
XCC-L-US-FR

Square Channels

XCC-C-SLM Standard Slim

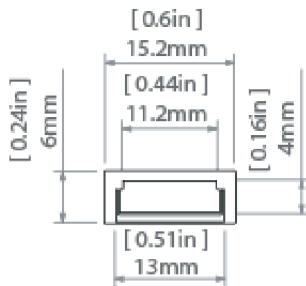

SKU				
Product	Collection	Name Code	Surface Code	Length
XCC	C	SLM	NA	1
				2
			BK	1
				2
			WT	2

Compatible XFL

22 - SW HD FS US DW TW

Description

Small dimensions (6mm / 0.25" high), extrusion can fit slim designs and thin furniture pieces. Lightweight, easily disperses heat. Internal and external bending radius of 150mm.

Material	XCC-E End Caps
NA BK WT	XCC-E-SLM-NA-NC-STD XCC-E-SLM-NA-NC-HOLE XCC-E-SLM-SA-NC-STD

XCC-L Lenses	XCC-M Mountings
<p>TL BK PRO CL PRO FR UNV CL UNV FR EX CL EX FR</p> <p>33% 91% 80% 85% 70% 89% 70%</p> <p>XCC-L-TL-BK XCC-L-UNV-FR XCC-L-PRO-CL XCC-L-EX-CL XCC-L-PRO-FR XCC-L-EX-FR XCC-L-UNV-CL</p>	<p>XCC-M-TYPA-BK-H XCC-M-SLM-NA-H XCC-M-TYPA-WT-H XCC-M-TYPA-NA-H XCC-M-TYPA-SA-H XCC-M-NS-NA-H XCC-M-SLM-NA-V XCC-M-ADJ-NA-A</p>
	Internal Channel Dimensions
	Height: 4mm Width for LED: 13mm

XCC-C-SS12 Standard Square 12

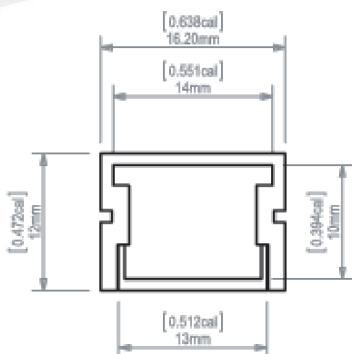
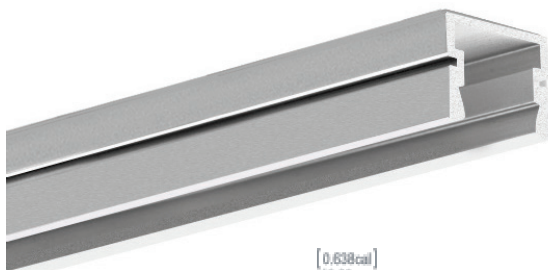

SKU				
Product	Collection	Name Code	Surface Code	Length
XCC	C	SS12	SA	1
				2

Compatible XFL

22 - SW HD FS US DW TW

Description

Designed for the construction of indoor lighting fixtures with increased ingress protection. Can be bent in the plane adjacent to the LED strip with internal bending radius 180mm and external bending radius 200mm.

Material	XCC-E End Caps
SA	XCC-E-S12-NA-EC-STD XCC-E-S12-BK-NC-STD XCC-E-S12-NA-NC-STD XCC-E-S12-SA-NC-STD XCC-E-S12-NA-NC-HOLE

XCC-L Lenses	XCC-M Mountings
<p>TL BK UNV CL UNV FR EX CL EX FR</p> <p>33% 85% 70% 89% 70%</p> <p>XCC-L-TL-BK XCC-L-EX-CL XCC-L-UNV-CL XCC-L-EX-FR XCC-L-UNV-FR</p>	<p>XCC-M-TYPA-BK-H XCC-M-SLM-NA-V XCC-M-TYPA-WT-H XCC-M-ADJ-NA-A XCC-M-TYPA-SA-H XCC-M-SLM-NA-V</p>
	Internal Channel Dimensions
	Height: 10mm Width for LED: 14mm

XCC-C-DS12

Designer Square 12

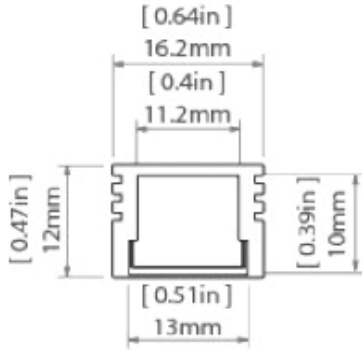

SKU				
Product	Collection	Name Code	Surface Code	Length
XCC	C	DS12		
			SA	1
			BK	2
				3
			WT	2
			NA	1
				2

Compatible XFL

22 - SW HD FS US DW TW

Description

Small 12mm height that offers flexibility for those hard to light applications. Easily embedded in narrow grooves or for back lighting luminaries.

Material	XCC-E End Caps
NA SA BK WT	XCC-E-S12-NA-EC-STD XCC-E-S12-BK-NC-STD XCC-E-S12-NA-NC-STD XCC-E-S12-SA-NC-STD XCC-E-S12-NA-NC-HOLE

XCC-L Lenses	XCC-M Mountings
TL BK PRO CL PRO FR UNV CL UNV FR EX CL EX FR	XCC-M-TYPA-BK-H XCC-M-SLM-NA-V XCC-M-TYPA-WT-H XCC-M-ADJ-NA-A XCC-M-TYPA-SA-H
33% 91% 80% 85% 70% 89% 70%	
XCC-L-TL-BK XCC-L-UNV-FR XCC-L-PRO-CL XCC-L-EX-CL XCC-L-PRO-FR XCC-L-EX-FR XCC-L-UNV-CL	
Internal Channel Dimensions	
Height: 10mm Width for LED: 11.2mm	

XCC-C-WTE-SA

Watertight External

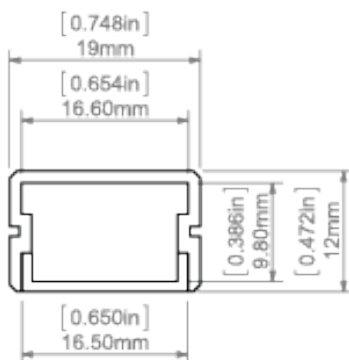
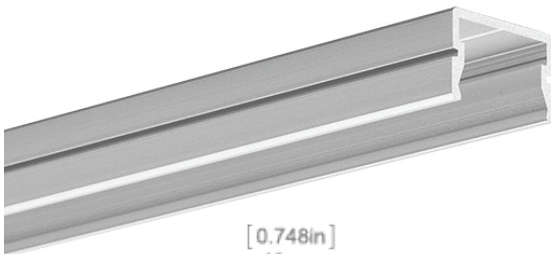

SKU				
Product	Collection	Name Code	Surface Code	Length
XCC	C	WTE	SA	
				1
				2

Compatible XFL

22 - SW HD FS US DW TW

Description

Designed for the construction of watertight lighting fixtures, for external use. Accommodates LEDs up to 0.55" / 14.6mm wide.

Material	XCC-E End Caps
SA	XCC-E-WTE-SA-NC-STD

XCC-L Lenses	XCC-M Mountings
WTE FR	XCC-M-D45-SA-H
68%	
XCC-L-WTE-FR	

Internal Channel Dimensions
Height: 9.8mm Width for LED: 16.5mm

XCC-C-SR14-SA
Shallow Rectangle 14

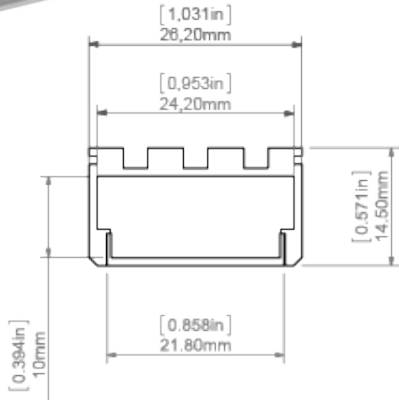
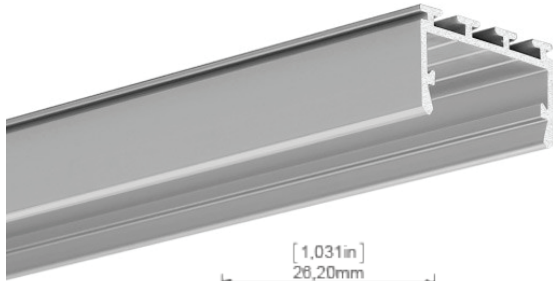

SKU				
Product	Collection	Name Code	Surface Code	Length
XCC	C	SR14	SA	1
				2
				3

Compatible XFL



Description

Designed to be a shallow channel with wide assortment of mounting accessories. Can be bent in the plane adjacent to the LED strip with internal bending radius 250mm and external bending radius 350mm.

Material	XCC-E End Caps
SA	XCC-E-SR14-NA-NC-STD XCC-E-SR14-NA-NC-HOLE

XCC-L Lenses	XCC-M Mountings
 70% 0% XCC-L-FF-FR XCC-L-PC-NL	XCC-M-SR14-NA-V XCC-M-SR14-BK-V XCC-M-SR14-NA-AJ XCC-M-SR14-NA-H1

Internal Channel Dimensions

Height: 10mm
Width for LED: 21.8mm

Recessed Channels

XCC-C-MRC2
Standard Micro Recessed

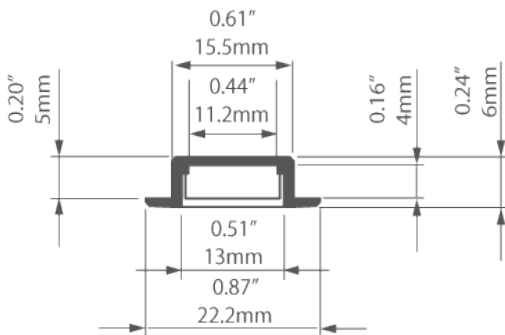
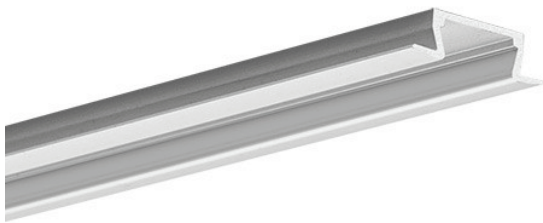

SKU				
Product	Collection	Name Code	Surface Code	Length
XCC	C	MRC2	SA	1
				2
			BK	1
				2

Compatible XFL



Description

Slim design with narrow collar enables unaesthetic grooves to be covered. Recessed shallow housing masks the edges of the groove, fits in 0.47" / 12mm thick drywall. Easy assembly, lightweight for lighting fixtures recessed in furniture boards.

Material	XCC-E End Caps
SA BK	XCC-E-MRC2-BK-NC-STD XCC-E-MRC2-NA-NC-STD

XCC-L Lenses	Internal Channel Dimensions
 33% 91% 80% 85% 70% 89% 70% XCC-L-TL-BK XCC-L-PRO-CL XCC-L-PRO-FR XCC-L-UNV-CL	Height: 4mm Width for LED: 11.2mm

XCC-C-REC2
Designer Recessed

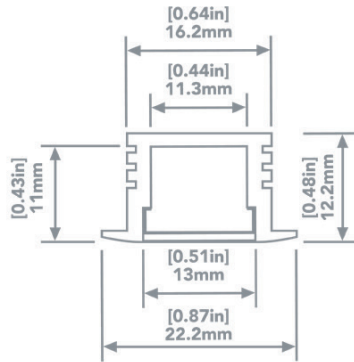
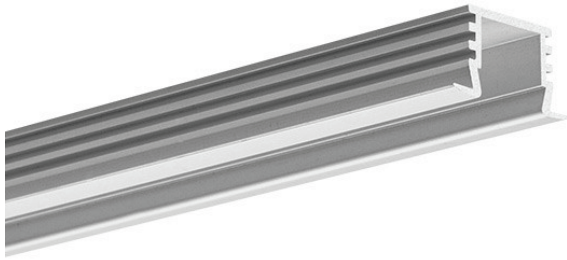

SKU				
Product	Collection	Name Code	Surface Code	Length
XCC	C	REC2		
			SA	1
				2
			BK	1
				2

Compatible XFL

22 - SW HD FS US DW TW

Description

Recessed with width of 11.3mm and height of 12.2mm with a lip for a smooth line that disappears.

Material	XCC-E End Caps
SA BK	XCC-E-REC2-NA-NC-STD XCC-E-REC2-BK-NC-STD XCC-E-REC2-NA-NC-HOLE XCC-E-REC2-BK-NC-HOLE

XCC-L Lenses	XCC-M Mountings
TL BK PRO CL PRO FR UNV CL UNV FR	XCC-M-TYPA-BK-H XCC-M-TYPA-SA-H

33% 91% 80% 85% 70%

XCC-L-TL-BK XCC-L-UNV-CL
XCC-L-PRO-CL XCC-L-UNV-FR
XCC-L-PRO-FR

Internal Channel Dimensions
Height: 10mm Width for LED: 11.2mm

XCC-C-DWC-NA
Drywall Ceiling

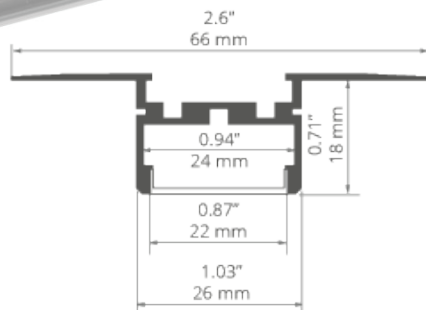
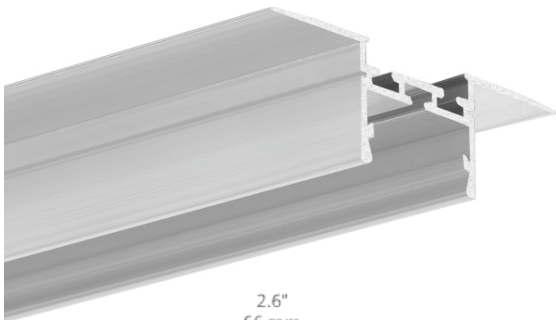

SKU				
Product	Collection	Name Code	Surface Code	Length
XCC	C	DWC	NA	
				1
				2

Compatible XFL

22 - SW HD FS US DW TW

Description

Designed to be mounted to 16mm drywall boards with no ceiling structure collision. Stable mounting to a suspended ceiling with invisible aluminum elements.

Material	XCC-E End Caps
NA	XCC-E-SR14-NA-NC-STD XCC-E-SR14-NA-NC-HOLE

XCC-L Lenses	Internal Channel Dimensions
PC NL	Height: <18mm Width for LED: 24mm
0%	
XCC-L-PC-NL	

45 Degree Channels

XCC-C-S45 Standard 45

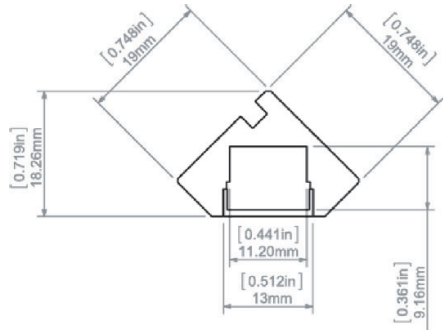
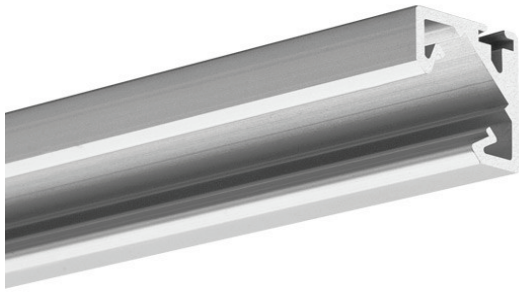

SKU				
Product	Collection	Name Code	Surface Code	Length
XCC	C	S45	SA	1
				2

Compatible XFL



Description

Designed to build low lighting fixtures for universal use. Provides 45° illumination for interior of cabinets, shelving and more. Smooth sides create a uniform line of light.

Material	XCC-E End Caps
SA	XCC-E-S45-NA-NC-STD

XCC-L Lenses	XCC-M Mountings
	XCC-M-DFH-NA-H1

33% 85% 70% 89% 70%
 XCC-L-TL-BK XCC-L-EX-CL
 XCC-L-UNV-CL XCC-L-EX-FR
 XCC-L-UNV-FR

Internal Channel Dimensions

Height: 10.8mm
 Width for LED: 9.16mm

XCC-C-D45 Designer 45

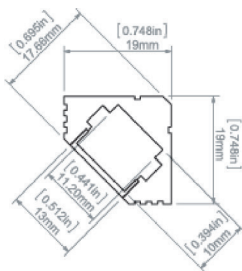
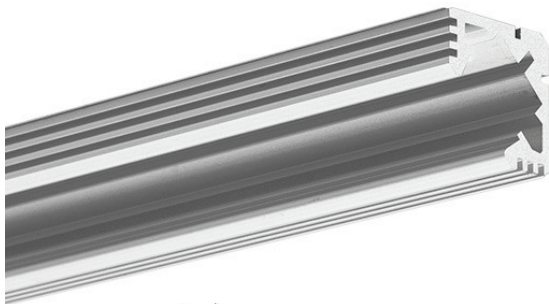

SKU				
Product	Collection	Name Code	Surface Code	Length
XCC	C	D45	SA	1
				2
				3
			BK	1
				2
			WT	2
				3

Compatible XFL



Description

Designed for mounting on surfaces with internal 90° corners that directs light at 45° angle.

Material	XCC-E End Caps
SA BK WT	XCC-E-D45-NA-NC-STD XCC-E-D45-BK-NC-STD XCC-E-D45-NA-NC-HOLE

XCC-L Lenses	XCC-M Mountings
	XCC-M-D45-SA-H

33% 85% 70% 89% 70%
 XCC-L-TL-BK XCC-L-EX-CL
 XCC-L-UNV-CL XCC-L-EX-FR
 XCC-L-UNV-FR

Internal Channel Dimensions

Height: 10mm
 Width for LED: 11.2mm

Hidden Mount Channels

XCC-C-MSQ

Standard Micro Square

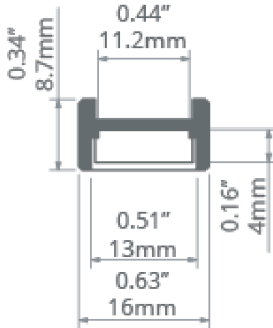

XCC-C-SS15

Standard Square 15

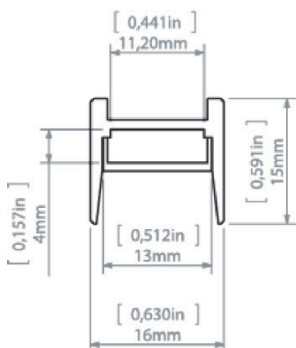
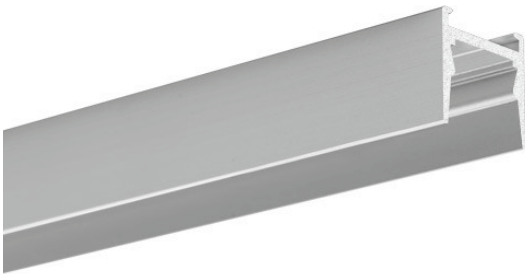

SKU

Product	Collection	Name Code	Surface Code	Length
XCC	C	MSQ	SA	1
				2

Compatible XFL

22 - SW HD FS US DW TW

Description

Intended for small linear lighting fixtures with concealed mounting bracket. Easy snap-in assembly.

Material	XCC-E End Caps
SA	XCC-E-MSQ-NA-NC-STD

XCC-L Lenses	XCC-M Mountings							
<table border="1"> <tr> <td>TL BK</td> <td>PRO CL</td> <td>PRO FR</td> <td>UNV CL</td> <td>UNV FR</td> <td>EX CL</td> <td>EX FR</td> </tr> </table>	TL BK	PRO CL	PRO FR	UNV CL	UNV FR	EX CL	EX FR	XCC-M-TYPA-NA-H
TL BK	PRO CL	PRO FR	UNV CL	UNV FR	EX CL	EX FR		

33%	91%	80%	85%	70%	89%	70%
XCC-L-TL-BK				XCC-L-UNV-FR		
XCC-L-PRO-CL				XCC-L-EX-CL		
XCC-L-PRO-FR				XCC-L-EX-FR		
XCC-L-UNV-CL						

Internal Channel Dimensions

Height: 4mm
Width for LED: 11.2mm

SKU

Product	Collection	Name Code	Surface Code	Length
XCC	C	SS15		
			SA	1
				2
			BK	1
				2

Compatible XFL

22 - SW HD FS US DW TW

Description

Allows the use of efficient, transparent covers while eliminating glare. Offers narrow beam angle. Good for back lighting, interior architecture and furniture.

Material	XCC-E End Caps
SA BK	XCC-E-SS15-NA-NC-STD XCC-E-SS15-BK-NC-STD

XCC-L Lenses	XCC-M Mountings					
<table border="1"> <tr> <td>TL BK</td> <td>UNV CL</td> <td>UNV FR</td> <td>EX CL</td> <td>EX FR</td> </tr> </table>	TL BK	UNV CL	UNV FR	EX CL	EX FR	XCC-M-TYPA-NA-H
TL BK	UNV CL	UNV FR	EX CL	EX FR		

33%	85%	70%	89%	70%
XCC-L-TL-BK				XCC-L-EX-CL
XCC-L-UNV-CL				XCC-L-EX-FR
XCC-L-UNV-FR				

Internal Channel Dimensions

Height: 10mm
Width for LED: 11.2mm

XCC-C-CS16

Designer Square Conceal 16

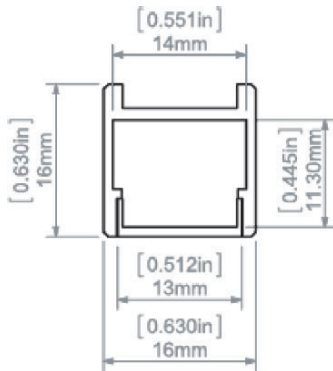

SKU				
Product	Collection	Name Code	Surface Code	Length
XCC	C	CS16	SA	1
				2
				3

Compatible XFL



Description

Similar design as the Designer Square 16 profile with a concealed mounting bracket. Clean shape, not distorted by technical detail, such as an external mounting bracket.

Material	XCC-E End Caps
SA	XCC-E-S16-NA-NC-STD

XCC-L Lenses	XCC-M Mountings
	XCC-M-NS-NA-H

33% 85% 70% 89% 70%

XCC-L-TL-BK XCC-L-EX-CL
 XCC-L-UNV-CL XCC-L-EX-FR
 XCC-L-UNV-FR

Internal Channel Dimensions

Height: 11.3mm
 Width for LED: 14mm

Hanging Channels

XCC-C-DS16

Designer Square 16

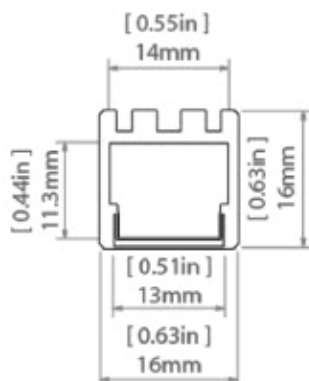

SKU				
Product	Collection	Name Code	Surface Code	Length
XCC	C	DS16	SA	1
				2
				3

Compatible XFL



Description

16mm extrusion with smooth side surfaces equipped with a small lock for system fasteners and extrusion connectors.

Material	XCC-E End Caps
SA BK WT	XCC-E-S16-NA-NC-STD

XCC-L Lenses	XCC-M Mountings
	XCC-M-HNG-NA-S XCC-M-HNG-SA-S

33% 85% 70% 89% 70%

XCC-L-TL-BK XCC-L-EX-CL
 XCC-L-UNV-CL XCC-L-EX-FR
 XCC-L-UNV-FR

Internal Channel Dimensions

Height: 11.3mm
 Width for LED: 14mm

XCC-C-C22

Designer Conceal 22

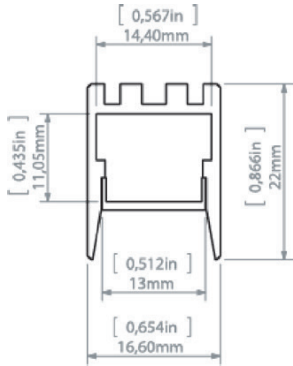

SKU				
Product	Collection	Name Code	Surface Code	Length
XCC	C	C22		
			SA	1
				2
			BK	1
				2

Compatible XFL



Description

Profile of 22mm height for narrow light angle hiding the light source. The recessed cover minimizes the glare. Great for continuous light arrangements.

Material	XCC-E End Caps
SA BK	XCC-E-C22-NA-NC-STD XCC-E-C22-BK-NC-STD
XCC-L Lenses	XCC-M Mountings
TL BK UNV CL UNV FR EX CL EX FR	XCC-M-HNG-NA-S XCC-M-HNG-SA-S
33% 85% 70% 89% 70%	
XCC-L-TL-BK XCC-L-UNV-CL XCC-L-UNV-FR	XCC-L-EX-CL XCC-L-EX-FR
Internal Channel Dimensions	
Height: 11mm Width for LED: 14.4mm	

XCC-C-RND

Designer Round

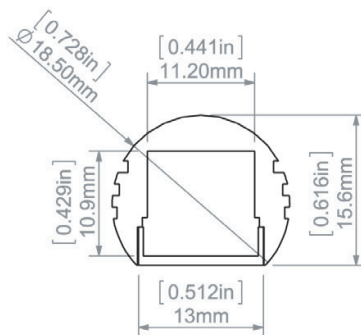
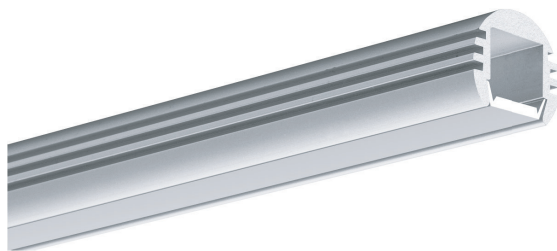

SKU				
Product	Collection	Name Code	Surface Code	Length
XCC	C	RND	SA	
				1
				2
				3

Compatible XFL



Description

Round extrusion with 18.5mm circumference for construction of linear suspended lighting fixtures.

Material	XCC-E End Caps
SA	XCC-E-RND-NA-EC-STD XCC-E-RND-NA-NC-STD XCC-E-RND-NA-NC-HOLE XCC-E-RND-SA-NC-STD
XCC-L Lenses	XCC-M Mountings
TL BK PRO CL PRO FR UNV CL UNV FR EX CL EX FR	XCC-M-TYPA-BK-H XCC-M-TYPA-WT-H XCC-M-TYPA-SA-H XCC-M-SLM-NA-H
33% 91% 80% 85% 70% 89% 70%	
XCC-L-TL-BK XCC-L-PRO-CL XCC-L-PRO-FR XCC-L-UNV-CL	XCC-L-UNV-FR XCC-L-EX-CL XCC-L-EX-FR
Internal Channel Dimensions	
Height: 10mm Width for LED: 11.2mm	

XCC-C-RSM

Designer Round Smooth

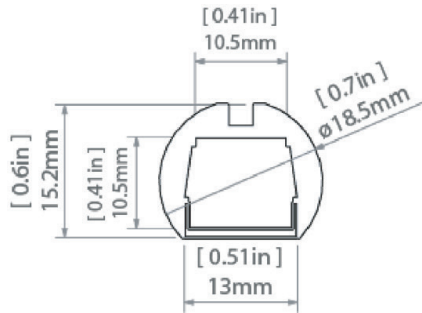

SKU				
Product	Collection	Name Code	Surface Code	Length
XCC	C	RSM	SA	1
				2

Compatible XFL

22 - SW HD FS SE US DW TW

Description

A modern smooth finish circular extrusion that can be easily designed as a finished lighting fixture.

Material	XCC-E End Caps
SA	XCC-E-RSM-NA-NC-STD XCC-E-RSM-NA-EC-STD
XCC-L Lenses	XCC-M Mountings
TL BK UNV CL UNV FR EX CL EX FR	XCC-M-HNG-NA-S XCC-M-HNG-SA-S
33% 85% 70% 89% 70%	
XCC-L Lenses	Internal Channel Dimensions
XCC-L-TL-BK XCC-L-UNV-CL XCC-L-UNV-FR	XCC-L-EX-CL XCC-L-EX-FR Height: 10.5mm Width for LED: 10.5mm

Specialty Channels

XCC-C-SPF

Specialty Focus

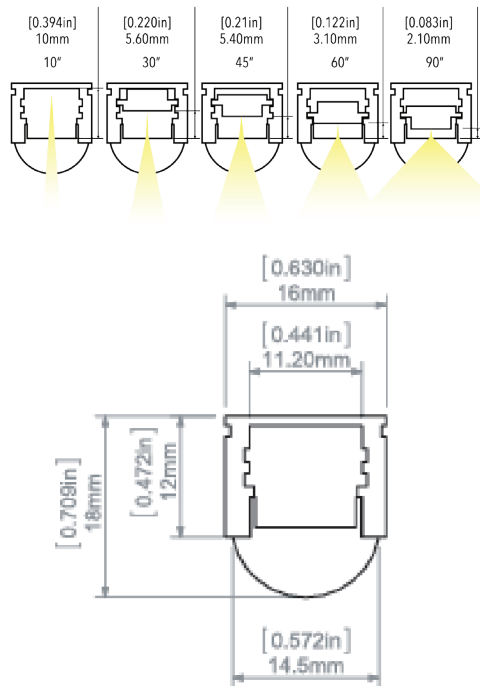

SKU				
Product	Collection	Name Code	Surface Code	Length
XCC	C	SPF	SA	1
				2
				3

Compatible XFL

22 - SW HD FS US DW TW

Description

Movable insert enables five different beam angles depending on the application. Adjustment enables 10, 30, 45, 60 and 90 degree beam angles.

Material	XCC-E End Caps
SA	XCC-E-SPF-NA-NC-STD XCC-E-SPF-NA-NC-HOLE
XCC-L Lenses	XCC-M Mountings
TL BK UNV CL UNV FR EX CL EX FR	XCC-M-TYPA-SA-H XCC-M-SLM-NA-H XCC-M-SLM-NA-V XCC-M-ADJ-NA-A
100% 33% 85% 70% 89% 70%	
XCC-L Lenses	Internal Channel Dimensions
XCC-L-SPF-CL XCC-L-TL-BK XCC-L-UNV-CL	XCC-L-UNV-FR XCC-L-EX-CL XCC-L-EX-FR Height: 2.1mm Width for LED: 11.2mm

XCC-C-GND

Standard In-Ground

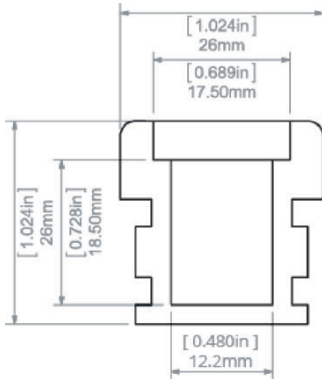
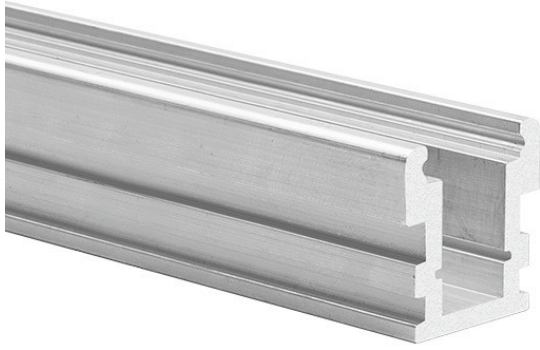

SKU				
Product	Collection	Name Code	Surface Code	Length
XCC	C	GND	NA	1
				2
				3

Compatible XFL

22 - SW HD FS US DW TW

Description

High load bearing capacity ideal for high-traffic areas such as sidewalks, bike paths, driveways. Environmentally friendly with special frosted cover.

Material	XCC-E End Caps
NA	XCC-E-GND-NA-NC-HOLE XCC-E-GND-NA-NC-STD
XCC-L Lenses	Internal Channel Dimensions
IG GRND 58% XCC-L-GND-FR	Height: 18.5mm Width for LED: 12.2mm

XCC-C-R17

Cove Recessed 17

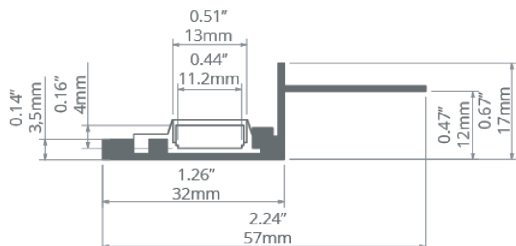

SKU				
Product	Collection	Name Code	Surface Code	Length
XCC	C	R17	NA	1
				2

Compatible XFL

22 - SW HD FS US DW TW

Description

Set of two extrusions designed for recessed illumination for ambient lighting of architectural niches located a short distance from the wall.

Material	XCC-E End Caps
NA	XCC-E-COVE-NA-NC-STD
XCC-L Lenses	Internal Channel Dimensions
PRO CL PRO FR UNV CL UNV FR EX CL EX FR 91% 80% 85% 70% 89% 70%	Height: 4mm Width for LED: 10.8mm
XCC-L-PRO-CL	XCC-L-UNV-FR
XCC-L-PRO-FR	XCC-L-EX-CL
XCC-L-UNV-CL	XCC-L-EX-FR

XCC-C-R32
Cove Recessed 32

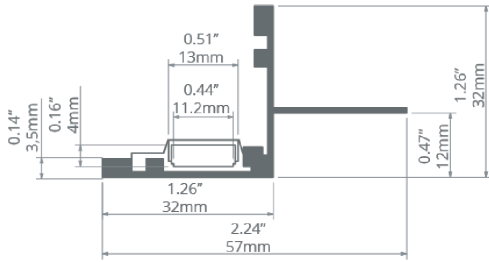

SKU				
Product	Collection	Name Code	Surface Code	Length
XCC	C	R32	NA	1
				2

Compatible XFL

22 - SW HD FS US DW TW

Description

Cove lighting system consisting of the mounting base and extrusion enabling parallel and perpendicular direction of light against a wall. Illumination of niches.

Material	XCC-E End Caps
NA	XCC-E-COVE-NA-NC-STD

XCC-L Lenses	Internal Channel Dimensions
<p>91% 80% 85% 70% 89% 70%</p> <p>XCC-L-PRO-CL XCC-L-UNV-FR</p> <p>XCC-L-PRO-FR XCC-L-EX-CL</p> <p>XCC-L-UNV-CL XCC-L-EX-FR</p>	<p>Height: 4mm</p> <p>Width for LED: 10.8mm</p>

XCC-C-CSL
Cove Slim

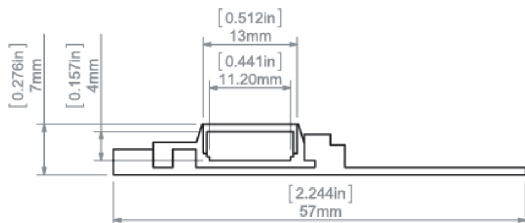

SKU				
Product	Collection	Name Code	Surface Code	Length
XCC	C	CSL	NA	1
				2

Compatible XFL

22 - SW HD FS US DW TW

Description

Set of two profiles designed for recessed illumination with a slim profile. Mounting strip and separate extrusion recessed inside for parallel light direction.

Material	XCC-E End Caps
NA	XCC-E-COVE-NA-NC-STD

XCC-L Lenses	XCC-M Mountings
<p>91% 80% 85% 70% 89% 70%</p> <p>XCC-L-PRO-CL XCC-L-UNV-FR</p> <p>XCC-L-PRO-FR XCC-L-EX-CL</p> <p>XCC-L-UNV-CL XCC-L-EX-FR</p>	<p>XCC-M-D45-SA-H</p>

Internal Channel Dimensions
<p>Height: 4mm</p> <p>Width for LED: 10.8mm</p>

Project: _____
 Designer: _____
 Fixture: _____



See legend at beginning of document

See legend at end of document

Ultra Slim Lenses: Narrow covers for slim profiles

XCC-L-US-FR Ultra Slim Frosted



70%

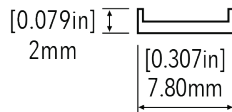

Description

Narrow cover that is compatible with the US Square channel and is UV resistant with good light diffusion. Transmits 70% light.

Compatible XCC-Channels

XCC-C-USS

XCC-C-USR

SKU

Product	Collection	Name Code	Surface Code	Length
XCC	L	US	FR	1
				2

Universal Series Lenses: Standard covers for most applications

XCC-L-PRO-CL Universal Clear - Pro



91%

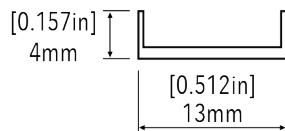

Description

Easy snap-in lens allows for simplified field installation measuring 13mm wide and 4mm in height with increased UV resistance. Transmits 91% light.

Compatible XCC-Channels

XCC-C-R17

XCC-C-SLM

XCC-C-MRC

XCC-C-MSQ

XCC-C-REC

XCC-C-R32

XCC-C-CSL

XCC-C-SPF

XCC-C-RND

XCC-C-DS12

SKU

Product	Collection	Name Code	Surface Code	Length
XCC	L	PRO	CL	1
				2

XCC-L-PRO-FR Universal Frosted - Pro



80%

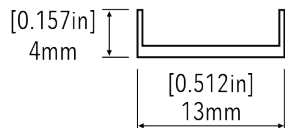

Description

Easy snap-in lens allows for simplified field installation measuring 13mm wide and 4mm in height. Increased UV resistance with 80% light transmission in the frosted version.

Compatible XCC-Channels

XCC-C-R17

XCC-C-SLM

XCC-C-MRC

XCC-C-MSQ

XCC-C-REC

XCC-C-R32

XCC-C-CSL

XCC-C-SPF

XCC-C-RND

XCC-C-DS12

SKU

Product	Collection	Name Code	Surface Code	Length
XCC	L	PRO	FR	1
				2

XCC-L-UNV-CL
Universal Clear

**UNV
CL**
85%

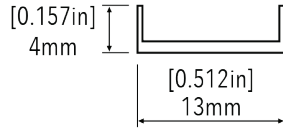

Description

Basic 13mm wide and 4mm in height lens that is compatible with most of Xicato's channels, not UV resistant so best for indoor applications. Transmits 85% light.

Compatible XCC-Channels				
XCC-C-R17	XCC-C-MRC	XCC-C-RSM	XCC-C-CSL	XCC-C-SLM
XCC-C-D45	XCC-C-SS12	XCC-C-CS16	XCC-C-REC	
XCC-C-RND	XCC-C-R32	XCC-C-MSQ	XCC-C-DS12	
XCC-C-DS16	XCC-C-C22	XCC-C-SS15	XCC-C-S45	
SKU				
Product	Collection	Name Code	Surface Code	Length
XCC	L	UNV	CL	
				1
				2

XCC-L-UNV-FR
Universal Frosted

**UNV
FR**
70%

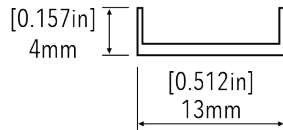

Description

Basic 13mm wide and 4mm in height lens that is compatible with most of Xicato's channels, not UV resistant so best for indoor applications. Transmits 70% light.

Compatible XCC-Channels				
XCC-C-R17	XCC-C-MRC	XCC-C-RSM	XCC-C-CSL	XCC-C-SLM
XCC-C-D45	XCC-C-SS12	XCC-C-CS16	XCC-C-REC	
XCC-C-RND	XCC-C-R32	XCC-C-MSQ	XCC-C-DS12	
XCC-C-DS16	XCC-C-C22	XCC-C-SS15	XCC-C-S45	
SKU				
Product	Collection	Name Code	Surface Code	Length
XCC	L	UNV	FR	
				1
				2

Extreme Series Lenses: For applications that require durable and rigid covers

XCC-L-EX-CL
Extreme Clear

**EX
CL**
89%

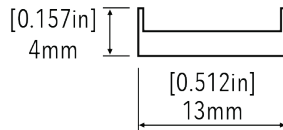

Description

13mm wide and 4mm in height, these rigid covers are durable under extreme climate condition. Double-sided UV protection withstanding temperatures of up to 248°F with 89% light transmission.

Compatible XCC-Channels				
XCC-C-R17	XCC-C-S45	XCC-C-RSM	XCC-C-CSL	XCC-C-MSQ
XCC-C-D45	XCC-C-SLM	XCC-C-CS16	XCC-C-REC	XCC-C-SS15
XCC-C-RND	XCC-C-R32	XCC-C-MRC	XCC-C-DS12	
XCC-C-DS16	XCC-C-C22	XCC-C-SS12	XCC-C-SPF	
SKU				
Product	Collection	Name Code	Surface Code	Length
XCC	L	EX	CL	
				1
				2
				3

XCC-L-EX-FR
Extreme Frosted



70%

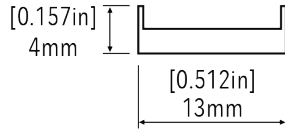

Description

13mm wide and 4mm in height, these rigid covers are durable under extreme climate condition. Double-sided UV protection withstanding temperatures of up to 248°F with 70% light transmission in the frosted version.

Compatible XCC-Channels				
XCC-C-R17	XCC-C-S45	XCC-C-RSM	XCC-C-CSL	XCC-C-MSQ
XCC-C-D45	XCC-C-SLM	XCC-C-CS16	XCC-C-REC	XCC-C-SS15
XCC-C-RND	XCC-C-R32	XCC-C-MRC	XCC-C-DS12	
XCC-C-DS16	XCC-C-C22	XCC-C-SS12	XCC-C-SPF	
SKU				
Product	Collection	Name Code	Surface Code	Length
XCC	L	EX	FR	
				1
				2
				3

Black Transition Lenses: Used for dark ceilings and environments when light is hidden when turned off

XCC-L-TL-BK
Black Transition Lens



33%

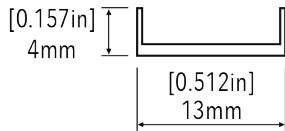
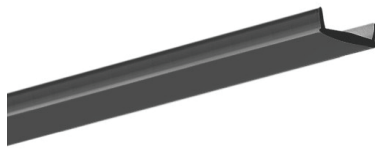

Description

Matte black surface that turns white when the light is turned on with 33% light transmission. The cover is made of UV-resistant PC measuring 13mm wide and 4mm in height. When the LEDs are off, the cover is black. The best visual effect is obtained in profiles that are black inside.

Compatible XCC-Channels				
XCC-C-D45	XCC-C-S45	XCC-C-RSM	XCC-C-SS12	XCC-C-SPF
XCC-C-RND	XCC-C-SLM	XCC-C-CS16	XCC-C-REC	XCC-C-MSQ
XCC-C-DS16	XCC-C-C22	XCC-C-MRC	XCC-C-DS12	XCC-C-SS15
SKU				
Product	Collection	Name Code	Surface Code	Length
XCC	L	TL	BK	
				1
				2

Focusing Lenses: Focused light at a specific angle

XCC-L-SPF-CL
Focusing Lens



100%

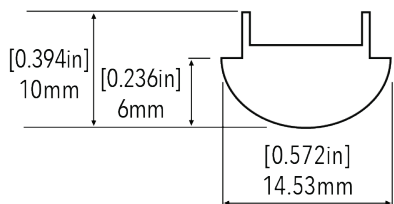

Description

Semi-transparent satin lens offers homogeneous line of light for focused lighting applications. Benefits include high transparency, quality and uniform cross-section. 14.53mm wide by 6mm in height. Transmits 100% light.

Compatible XCC-Channels				
XCC-C-SPF				
SKU				
Product	Collection	Name Code	Surface Code	Length
XCC	L	FL	CL	
				1
				2
				3

In-Ground Lenses: Durable cover for ground applications

XCC-L-GND-FR In-Ground Frosted



58%

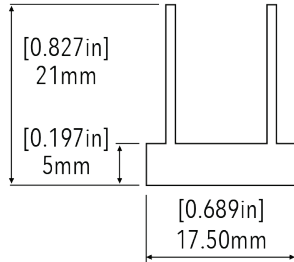

Description

Sturdy lens that easily adapts to the In-Ground channel to seal the fixture. Lens has good fire and mechanical resistance with complete UV protection. Transmits 58% light.

Compatible XCC-Channels

XCC-C-GND

SKU

Product	Collection	Name Code	Surface Code	Length
XCC	L	IG	FR	1
				2
				3

Watertight Lenses: Cover for waterproof channels

XCC-L-WTE-FR Watertight Frosted



86%

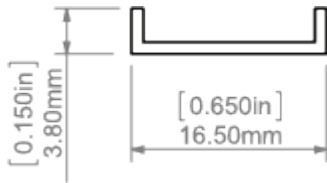

Description

Dedicated lens cover for waterproof WTE channel. For obtaining a line of light and very good light diffusion. Made of polycarbonate. No UV resistance.

Compatible XCC-Channels

XCC-C-WTE-SA

SKU

Product	Collection	Name Code	Surface Code	Length
XCC	L	WTE	FR	1
				2

Flexible Lenses: Bendable cover designed for flexible channels

XCC-L-FF-FR Flexible Frosted



70%

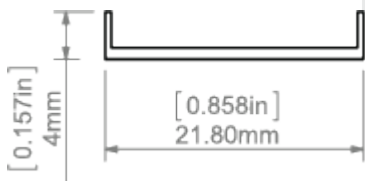

Description

Flexible lens cover with excellent diffusion properties and uniform cross-section. Recommended for bent channels. Made of polycarbonate. Increased UV resistance.

Compatible XCC-Channels

XCC-C-SR14-SA

SKU

Product	Collection	Name Code	Surface Code	Length
XCC	L	FF	FR	1
				2
				3

Protective Lenses: Protects inside of channels during finishing work

XCC-L-PC-NL
Protective Cover



0%

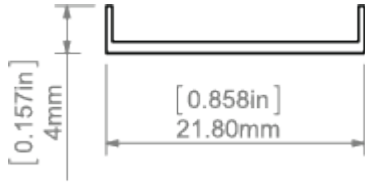

Description

Protective lens cover designed to protect the inside of a channel during construction or finishing work. Cover can be used multiple times. Made of PVC. No UV resistance.

Compatible XCC-Channels

XCC-C-SR14-SA

XCC-C-DWC-NA

SKU

Product	Collection	Name Code	Surface Code	Length
XCC	L	PC	NL	1
				2



Xicato Global Headquarters

102 Cooper Court,
Los Gatos, CA 95032

Contact Us

Tel: +1 866 223 8395
info@xicato.com
www.xicato.com

For the most up-to-date data sheet, please visit xicato.com/support.