

DATA SHEET

Xicato Bluetooth Control Cards (XGC)

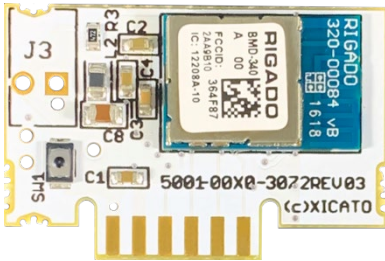

Figure 1: XGC-LCI-U3



Figure 2: XGC-01-xxx-U3

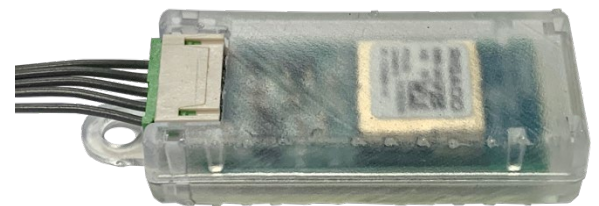

Figure 3: XGC-02-xxx-U3

About Xicato

Xicato is defining the future of smart buildings, delivering the absolute best quality, highest performing and most reliable light sources, as well as other wirelessly connected intelligent devices including drivers, sensors, switches, gateways, controls electronics, and software. Xicato products inspire architects, designers and building owners to dream up and create more beautiful, healthy environments with smarter and more connected experiences. With an installed base approaching 10 million nodes, throughout thousands of locations in over 30 countries worldwide, and backed by a strong team of innovators based in Silicon Valley, Xicato continues to stay ahead of customer needs in a variety of verticals including the world's most renowned museums and cathedrals, retail shops and hotels, offices and hospitals. Xicato and the Xicato logo are registered trademarks of Xicato, Inc.

For further information, visit www.xicato.com.

TABLE OF CONTENTS

Xicato Bluetooth Control Cards (XGC) 1

 Table of Contents..... 2

 Xicato Bluetooth® Control Cards 3

 XGC Features..... 4

 Ordering Guide 6

 Mechanical Specifications 7

 Mechanical Drawings..... 8

 Electrical Specifications 11

 Wireless Specifications 13

 XGC Device Type Support 14

 Warranty..... 15

 Regulatory & Agency Approvals 15

XICATO BLUETOOTH® CONTROL CARDS

XGC is a family of Bluetooth radio modules that can be integrated internally or externally with a wide variety of devices to enable meshed Bluetooth control. The XGC supports two types of device interfaces, LCI (Load Control Interface) for integration with a wide variety of 3rd party devices and XDI (Xicato Driver Interface) for Xicato Driver products. XGC models are available that support Xicato’s proprietary Xmesh protocol or Bluetooth Mesh. The XGC allows OEMs to quickly and easily ready their devices for the Internet of Things (IoT).

XGC comes in a variety of form factors to meet the needs of different internal or external Bluetooth control applications:

Load Control Interface (LCI) Products

LCI products are specifically designed to be integrated with 3rd party products that represent a controllable load (e.g., lights, shade controllers, actuators, etc.). An LCI product is configured by an OEM to meet the specific requirements of the OEM’s end product.

- XGC-LCI-U3 is a PCBA designed for integration with a device using a 6-pin card edge connector.
- XGC-01-LCI-U3 is a PCBA designed for integration with a device using a 10-pin (0.5mm pitch) flat flexible cable..
- XGC-02-LCI-U3 is a housed version of XGC designed for integration with a device using a 5-pin (1.5mm pitch) wire connector.

Xicato Driver Interface (XDI) Products

XDI products are specifically designed to be integrated with Xicato drivers. The functionality of the XDI is specific to Xicato Drivers and XDI products are not interchangeable with LCI products.

- XGC-01-XDI-U3 is a PCBA (same physical form factor as the XGC-01-LCI-U3) designed to be integrated with and provide Bluetooth control for Xicato’s XMD01 family of LED driver PCBAs.
- XGC-02-XDI-U3 is a housed product (same physical form factor as the XGC-02-LCI-U3) designed to be integrated with and provide Bluetooth control for Xicato’s XMD02, XMD03, XMV02 and XMV03 LED drivers.

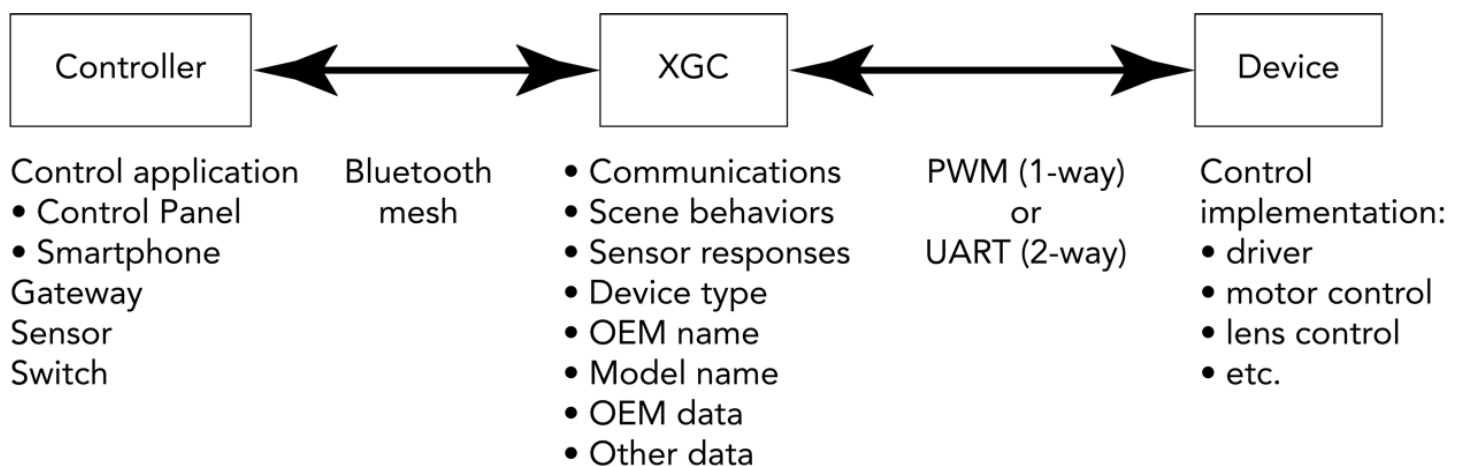

XGC FEATURES

INTERNAL OR EXTERNAL APPLICATIONS

Xicato control cards (XGC) are available in form factors that can be edge-inserted into standard connectors on the inside of a device, or connected to the device via standard cables and connectors to allow placement of the Bluetooth® radio inside or outside luminaires or other controllers to optimize radio performance.

UNIVERSAL, PROGRAMMABLE BASE LOAD (LCI FIRMWARE)

XGC comes with a universal base load that can be programmed using the XGC configuration tool to support a wide variety of load control devices... everything from single- or multi-channel LED drivers and protocol bridges, to shade controllers, fan motors, beam angle controllers, and more. Device manufacturers program their manufacturer ID, model number, device personality, serial number and optional OEM data into the module for reporting to application software.

PWM OR BIDIRECTIONAL SERIAL DEVICE COMMUNICATION

XGC can be programmed to communicate with the OEM device using PWM, or for more flexibility and power, over a UART-based serial interface that not only provides more device type options, but also provides two-way communication with the device, allowing device data reporting over Bluetooth to application software.

WIRELESS DATA REPORTING

XGC allows devices to regularly transmit their current level settings, temperature, total operating hours, and more, allowing proactive maintenance. It also stores a histogram of levels and temperature for the life of the device, which can be downloaded on request from an application for lifecycle analysis and confirmation of warranty compliance. Among other things, this allows Xicato (and the OEM) to verify compliance with warranty terms, and allows users to plan replacement intervals well in advance.

BLUETOOTH BEACONS

XGC provides a Bluetooth radio that allow devices to broadcast Apple® iBeacons, Eddystone URI beacons, and/or Alt Beacons, enabling a wide variety of location-based information and navigation services. Bluetooth beacons can act as indoor GPS satellites, allowing mobile apps to provide highly granular, accurate location of users in retail shops, hotels, restaurants, museums, airports, or other public and commercial spaces. Beacons can also trigger web searches, information screens, or other application responses based on a user's proximity to exhibits, merchandise, or other points of interest.

CONFIGURABLE ADVERTISING POWER AND INTERVAL

XGC allows users to set different advertising frequencies (cadence) and power levels for beacons, operational data, and status messages, depending on their specific application requirements.

INTERNAL SENSOR DATA COLLECTION & STORAGE

XGC supports the following sensor related functions

Real-time reporting	Intensity or other level (commanded by XGC) Other commanded parameters Temperature of electronics printed circuit board (PCB). Group membership (provisioned) Scene membership (provisioned) Input power, voltage and ripple*
Stored operating history	Total operating hours (at > 0% intensity) Power cycles (power on/off) Commanded on/ff cycles (e.g. LEDs turned on/off, unit still powered) Histogram of time spent in 12 level ranges: 0%, 0.1-1.0%, 1-10%, 11-20%, ..., 91-100%

Stored module Information	XGC part number
	Serial number
	XGC hardware revision
	XGC firmware revision
	Bluetooth firmware revision
Stored OEM programming	OEM ID code (identifies device as manufactured by OEM)
	OEM Model (optional)
	Other OEM data reported over RDM

* If reported by device over RDM. XGC cannot validate any values reported by the device to which it is connected

ORDERING GUIDE

XGC NUMBERING CONVENTION

Product	Form Factor/Design	Firmware	Internal Detail
XGC	00 = <blank> = PCBA, 6 pin card edge connector 01 = PCBA, 10 pin FPC connector 02 = housed, 5 pin wire connector	LCI = Load Control Interface XDI = Xicato driver interface	U3

ORDER CODES



MODEL	DESCRIPTION
XGC-LCI-U3	Xicato control card, PCBA 6 pin edge connector, universal load control interface
XGC-01-LCI-U3	Xicato control card, PCBA 10 pin FPC connector, universal load control interface
XGC-02-LCI-U3	Xicato control card, housed PCBA 5 pin wire connector, universal load control interface
XGC-01-XDI-U3	Xicato control card, PCBA 10 pin FPC connector, for XMD01
XGC-02-XDI-U3	Xicato control card, housed PCBA 5 pin wire connector, for XMD01, XMD03, and XMV drivers
XDA-001	Ribbon cable, FFC 0.50mm, 10 conductor, 65mm, Molex 0152660603 for XGC-01-* cards
XDA-002	Wire harness, 6in, 5-pin, pin 1 to pin 1, JST A05ZR05ZR28H152A, for XGC-02-* cards

Notes:

1. Ribbon cables and wire harnesses should be ordered separately per count and type of XGC card. They are widely available, off the shelf products from Molex or JST, and carried by Xicato as a convenience to our customers.

MECHANICAL SPECIFICATIONS

XGC FOR EXTERNAL CONNECTION

	XGC-01-xxx-U3	XGC-02-xxx-U3
Images	 <p>Figure 4: XGC-B8-xx-01 showing cable end</p>	 <p>Figure 5: XGC-B8-xxx-02 in clear prototype housing, showing cable end</p>
Form Factor	PCBA	V0 halogen free plastic housing White
Dimensions	26.5mm x 12.5mm x 3mm	35mm x 15mm x 8mm (housing) 41mm x 15mm x 8mm w/screw tab
Weight	< 1 gram	1 gram
Electrical and Communications I/O	10 pin FFC/FPC connector, poke-in to driver and dongle, e.g. Molex 0152660603	5 wire cable snap-in connector e.g. JST A05ZR05ZR28H152A
Operating Temperature (°C)	-25°C to +80°C	-25°C to +80°C
Storage Temperature (°C)	-40°C to +85°C	-40°C to +85°C

XGC FOR INTERNAL CONNECTION

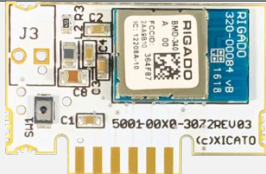
	XGC-LCI-U3
IMAGE	
FORM FACTOR	PCBA
DIMENSIONS	26.5mm x 12.5mm x 3mm
WEIGHT	< 1 gram
ELECTRICAL AND COMMUNICATIONS I/O	6-pin card-edge connection
MATING CONNECTOR	AVX 009159006551906
OPERATING TEMPERATURE	-25°C to +80°C
STORAGE TEMPERATURE	-40°C to +85°C

MECHANICAL DRAWINGS

XGC-LCI-U3

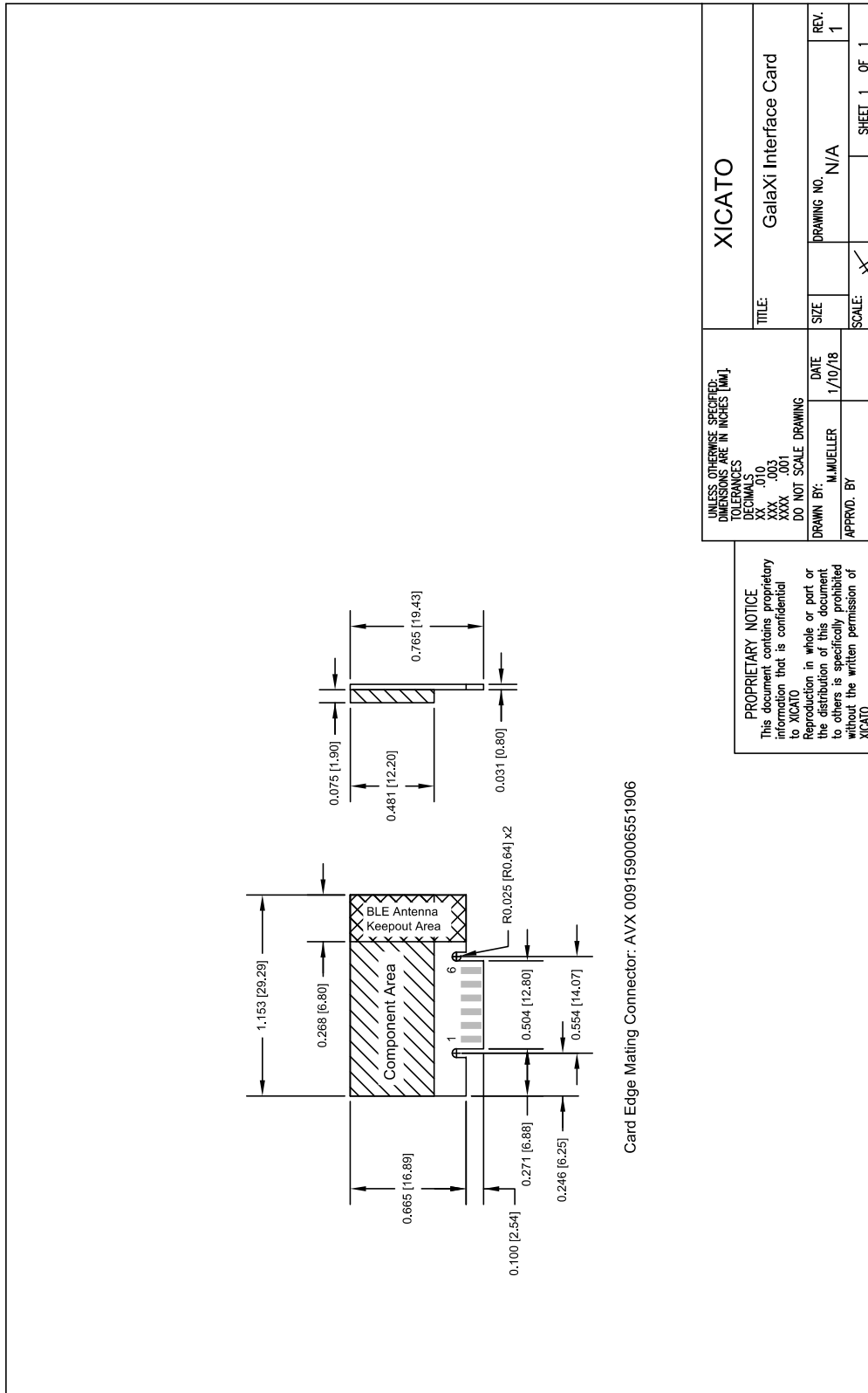

Card Edge Mating Connector: AVX 009159006551906

PROPRIETARY NOTICE
 This document contains proprietary information that is confidential to XICATO.
 Reproduction in whole or part or the distribution of this document to others is specifically prohibited without the written permission of XICATO.

UNLESS OTHERWISE SPECIFIED: DIMENSIONS ARE IN INCHES [MM]		XICATO	
TOLERANCES DECIMALS XX .010 XXX .003 XXX .001 DO NOT SCALE DRAWING	DATE 1/10/18	TITLE: Galaxi Interface Card	
DRAWN BY: M.MUELLER	SCALE: N/A	SIZE	REV. 1
APPROV. BY:		DRAWING NO. N/A	SHEET 1 OF 1

XGC-01-XXX-U3

Coming soon.

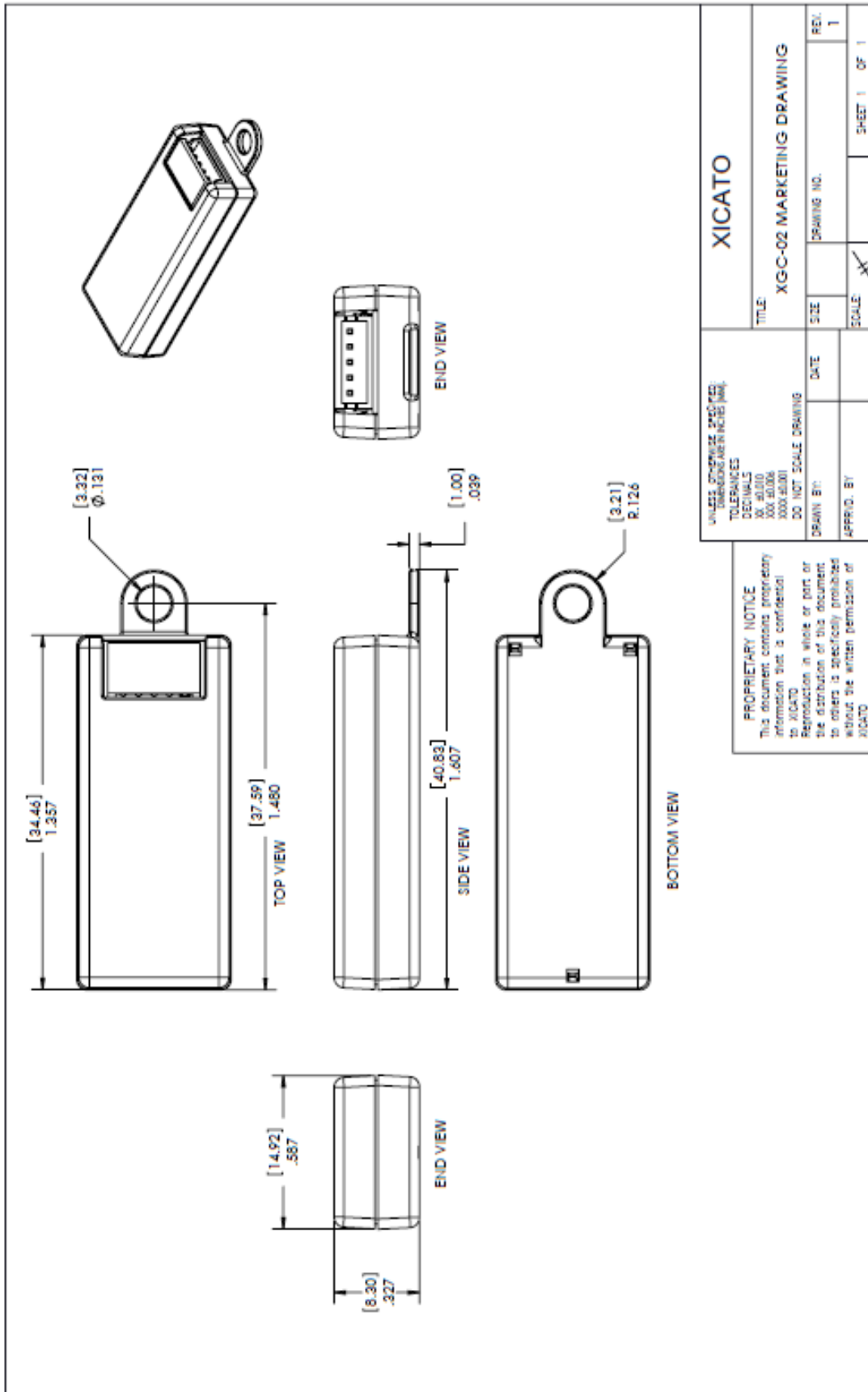

ELECTRICAL SPECIFICATIONS

Specification	XGC-XXX-U3	XGC-01-XXX-U3	XGC-02-XXX-U3	NOTES
Supply Voltage	3.3V ± 0.3V DC	3.3V ± 0.3V DC	4.5V to 24V DC	
Communication pin Voltage	3.3V ± 0.3V DC	3.3V ± 0.3V DC	3.3V ± 0.3V DC	
Current Consumption	12mA @ 3.3V	12mA@ 3.3V	12mA @ 5V	1, 2
Internal protocols	PWM or UART-based Serial			3
PWM frequency (configurable)	100 Hz to 60 kHz, affecting all channels			3
PWM channel phase	Channel duty cycles are in phase			3
UART data rate	Up to 250k baud, configurable			3

1. Typical current consumption under normal operation with Tx power set to +8dBm.
2. Current consumption on XGC-02-xxx-U3 is constant across the operating voltage range.
3. Applicable to XGC-LCI products only.

XGC-LCI-U3 PINOUT

	PWM mode	Serial (UART) mode
Pin 1	VCC (+3.3V)	VCC (+3.3V)
Pin 2	VSS (GND reference for VCC)	VSS (GND reference for VCC)
Pin 3	PWM channel 1 (note 4)	Serial Rx
Pin 4	Unused (note 3) or PWM channel 2 (note 4)	Serial Tx
Pin 5	Unused (note 3) or PWM channel 3 (note 4)	Unused
Pin 6	Unused (note 3), PWM channel 4 (note 4) or Relay Control (note 5)	Unused

NOTES:

1. Noise filtering is provided on the board for the BLE radio, but there is no on-board regulation
2. The card cannot be hot plugged. If the card is hot plugged it will almost certainly be damaged.
3. These pins should not be connected to anything off the card. Damage or unanticipated behavior may occur.
4. PWM frequency is programmable between 100 Hz and 60 kHz
5. This is the default output for the single channel PWM mode that supports relay control as well.

XGC-01-LCI-U3 PINOUT

	PWM mode	Serial (UART) mode
Pin 1	No connect	No connect
Pin 2	PD/VSS (note 6)	PD/VSS (note 5)
Pin 3	Unused (note 3) or PWM channel 3 (note 4)	Unused (note 3)
Pin 4	Unused (note 3) or PWM channel 4 (note 4) or Relay Control (note 5)	Unused (note 3)
Pin 5	Do not connect (note 3)	Do not connect (note 3)
Pin 6	Do not connect (note 3)	Do not connect (note 3)
Pin 7	Unused (note 3) or PWM channel 2 (note 4)	Serial Tx
Pin 8	PWM channel 1 (note 4)	Serial Rx
Pin 9	VSS (GND reference for VCC)	VSS (GND reference for VCC)
Pin 10	VCC (+3.3V)	VCC (+3.3V)

NOTES:

- Noise filtering is provided on the board for the BLE radio, but there is no on-board regulation
- The card cannot be hot plugged. If the card is hot plugged it will almost certainly be damaged.
- If Unused or Do not connect, the pin should not be connected to anything off the card. Damage or unanticipated behavior may occur.
- PWM frequency is programmable between 100 Hz and 60 kHz
- This is the default output for the single channel PWM mode that supports relay control as well.
- This pin is tied to VSS internally and can either be tied to VSS on the system board it connects to or be used as a Presence Detect (PD) signal to indicate when a card is populated in the system.

XGC-02-LCI-U3 PINOUT

	PWM mode	Serial (UART) mode
Pin 1	VCC (4.5V to 24V)	VCC (4.5V to 24V)
Pin 2	VSS (GND reference for VCC)	VSS (GND reference for VCC)
Pin 3	Unused (note 3) or PWM channel 3 (note 4)	Unused (note 3)
Pin 4	Unused (note 3) or PWM channel 2 (note 4)	Serial Tx
Pin 5	PWM channel 1 (see note 4)	Serial Rx

NOTES:

- Noise filtering is provided on the board for the BLE radio, with on-board power regulation
- The card cannot be hot plugged. If the card is hot plugged it will almost certainly be damaged.
- If Unused the pin should not be connected to anything off the card. Damage or unanticipated behavior may occur.
- PWM frequency is programmable between 100 Hz and 60 kHz

WIRELESS SPECIFICATIONS

Feature	Specification
Processor	ARM Cortex M0, 32-bit, 48 MHz
Wireless Protocol	Bluetooth 5
Wireless Spectrum	2.4 GHz ISM band
Bandwidth	1 Mbps (2 Mbps capable)
Channels	40
Transmit Power	Configurable in 1 dBm increments to +8.0 dBm
Receive Sensitivity	-95 dBm
RSSI Resolution	1 dBm

XGC DEVICE TYPE SUPPORT

PWM MODE

Mode	Description
1E	Single-channel on/off control
1D1E	Single-channel device controller with separate on/off 0-100% dimming, where 0% activates on/off relay
1D	Single-channel on/off/dim control: 0-100% dimming
M2D	Master + 2 channels with dimming. One Master slider, and one for each of the 2 channels.
M4D	Master + 4 channels with dimming. One Master slider, and one for each of the 4 channels.
B2D	Bonded 2 channels with dimming controlled by a single slider
B4D	Bonded 4 channels with dimming controlled by a single slider
1K	Master + 2 cross-tuned channels

SERIAL (UART) MODE

Serial mode can operate in 8-bit mode (255 steps), or 16-bit mode (65535 steps) for greater control granularity. Details of UART control modes are explained in the XGC UART Interface Specification, available from Xicato.

Mode	Description
1E	Single-channel on/off control
1D1E	Single-channel on/off/dim control: 0-100% dimming, where 0% activates on/off relay
1D	Single-channel on/off/dim control: 0-100% dimming
M2D	Master + 2 channels with dimming. One Master slider, and one for each of the 2 channels.
M4D	Master + 4 channels with dimming. One Master slider, and one for each of the 4 channels.
B2D	Bonded 2 channels with dimming controlled by a single slider
B4D	Bonded 4 channels with dimming controlled by a single slider
M2X	Master (intensity) + 2-channel linear cross-fade (100%/0% to 0%/100%) e.g. for tunable white (CCT)
CCT	CCT control: CCT value given in 255 increments or in K
CHSL	4 sliders: CCT, Hue (0-360°), Saturation (0-100°) and Lightness (0-100% intensity) control.
Shade	Shade control: open to closed in 255 or 65535 steps
Beam	Configurable start and stop angle up to 0-360° in 255 or 65535 steps
Pan	Pan mechanism control: configurable start and stop angle up to 0-360° in 255 or 65535 steps
Tilt	Tilt mechanism control: configurable start and stop angle up to 0-360° in 255 or 65535 steps

WARRANTY

Warranty duration: 5 years
 Temperature and power parameters must be kept within recommended specifications.
 Verification based on actual operating data stored in each module.

Warranty coverage: B0: Covers electronics on EVERY module. No failures.

Full warranty text at: www.xicato.com/support/warranty

REGULATORY & AGENCY APPROVALS

CHEMICAL SAFETY

The following chemicals should be avoided, even in small quantities, within the module:

Hydrochloric Acid	MEK (Methyl Ethly Ketone)	Dichloromethane
Sulfuric Acid	MIBK (Methyl Isobutyl Ketone)	Rosin Flux Solder
Nitric Acid	Toluene	Castor Oil
Acetic Acid	Xylene	Lard Oil
Sodium Hydroxide	Benzene	Linseed Oil
Potassium Hydroxide	Gasoline	Petroleum Oil
Ammonia	Mineral Spirits	Silicone Oil
Sulfur (Used in Rubber Processing)	Tetracholoromethane (Carbon tetrachloride – CCl ₄)	Halogenated Hydrocarbons (Containing F, Cl, or Br)

ENVIRONMENTAL SAFETY

RoHS and REACH compliant

Heavy metal content

Lead:	None
Mercury:	None
Cadmium:	None
Hexavalent Chromium:	None
UV or IRC Emissions:	None

WIRELESS COMPLIANCE

UNITED STATES

FCC NOTICE: This device complies with Part 15 of the FCC Rules. The device meets the requirements for the modular transmitter approval as detailed in FCC public Notice DA00-1407. Transmitter Operation is subject to the following two conditions: (1) This device may not cause harmful interference, and (2) This device must accept any interference received, including interference that may cause undesired operation.

NOTE: This equipment has been tested and found to comply with the limits for a Class B digital device, pursuant to Part 15 of the FCC Rules. These limits are designed to provide reasonable protection against harmful interference in a residential installation. This equipment generates and can radiate radio frequency energy and, if not installed and used in accordance with the instructions, may cause harmful interference to radio communications. However, there is no guarantee that interference will not occur in a particular installation. If this equipment does cause harmful interference to radio or television reception, which can be determined by turning the equipment off and on, the user is encouraged to try to correct the interference by one or more of the following measures:

- Reorient or relocate the receiving antenna.
- Increase the separation between the equipment and receiver.
- Connect the equipment into an outlet on a circuit different from that to which the receiver is connected.
- Consult the dealer or an experienced radio/TV technician for help

LABELING REQUIREMENTS: The Original Equipment Manufacturer (OEM) must ensure that FCC labelling requirements are met. This includes a clearly visible label on the outside of the OEM enclosure specifying the appropriate FCC identifier for this product as well as the FCC Notice above. The FCC identifier must be labeled on the exterior of the end product as "FCC ID: 2AA9B10"

CANADA

ISED NOTICE: The device complies with Canada RSS-GEN Rules. The device meets the requirements for modular transmitter approval as detailed in RSS-GEN. Operation is subject to the following two conditions: (1) This device may not cause harmful interference, and (2) This device must accept any interference received, including interference that may cause undesired operation.

L'appareil est conforme aux Règles RSS-GEN de Canada. L'appareil répond aux exigences d'approbation de l'émetteur modulaire tel que décrit dans RSS-GEN. L'opération est soumise aux deux conditions suivantes: (1) Cet appareil ne doit pas causer d'interférences nuisibles, et (2) Cet appareil doit accepter toute interférence reçue, y compris les interférences pouvant entraîner un fonctionnement indésirable.

ISED INTERFERENCE STATEMENT FOR CANADA

This device complies with Innovation, Science and Economic Development (ISED) Canada licence-exempt RSS standard(s). Operation is subject to the following two conditions: (1) this device may not cause interference, and (2) this device must accept any interference, including interference that may cause undesired operation of the device.

Cet appareil est conforme à la norme sur l'innovation, la science et le développement économique (ISED) norme RSS exempte de licence. L'exploitation est autorisée aux deux conditions suivantes : (1) l'appareil ne doit pas produire de brouillage, et (2) l'utilisateur de l'appareil doit accepter tout brouillage radioélectrique subi, même si le brouillage est susceptible d'en compromettre le fonctionnement.

ISED RADIATION EXPOSURE STATEMENT FOR CANADA

This equipment complies with ISED radiation exposure limits set forth for an uncontrolled environment.

Cet équipement est conforme aux limites d'exposition aux radiations ISED prévues pour un environnement incontrôlé.

LABELING REQUIREMENTS:

The Original Equipment Manufacturer (OEM) must ensure that ISED labelling requirements are met. This includes a clearly visible label on the outside of the OEM enclosure specifying the appropriate IC identifier for this product as well as the ISED Notice above. The IC identifier must be labeled on the exterior of the end product as "IC: 12208A-10".

EUROPE

Declaration of Conformity: Hereby, Xicato declares that the XGC series products comply with the essential requirements and other relevant provisions of RED 2014/53/EU.